



Spare Parts



Baseball Products



Bleachers & Benches



Contact Us

Outfield/Utility Fencing Field Layout

1. Use a line anchored at home plate for curve reference. Start at the Foul Line and measure off and mark all Ground Socket locations 10 feet apart.
2. If you are using the **SmartPost™ Kits**: Create pilot holes and install all Ground Sockets into marked locations. See Ground Socket instruction details. Assemble and insert all posts into sockets.
- 2a. If you are using the **SmartStake™ Kits**: Create pilot holes, then assemble and insert all stakes into ground at marked locations.

3. This is what a 100 ft. section in left field should look like at this point.

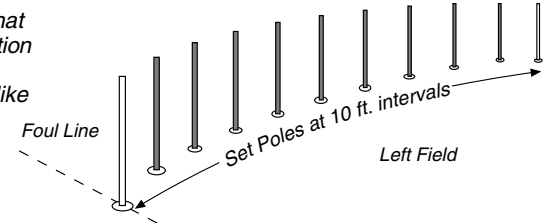

4. See fence installation instructions. Remember to slide the Sleeves as needed to tighten or loosen Fence fabric. Make sure the bottom of fence fabric is secure at Ground level.
Note: Gateways can be used for any application, such as snow fence or crowd control, to provide easy exit & entry and to avoid fencing damage.

Choose one of these layouts for your outfield.

(Your kit will determine which layout to use.)

Based upon your needs, 2,3, or more fence kits may be required.

2 Section Layout - for 300 ft. fence

Each section:
150 ft., 16 poles
10 ft. spacing

We recommend gateways as shown to provide easy exit and entry, and to avoid fence damage.

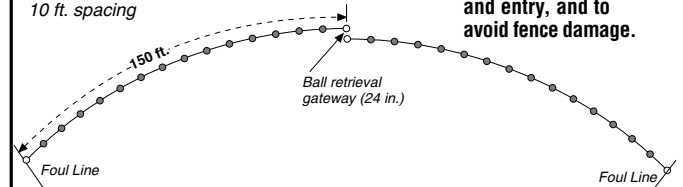

3 Section Layout - for 450 ft. fence

Each section:
150 ft., 16 poles
10 ft. spacing

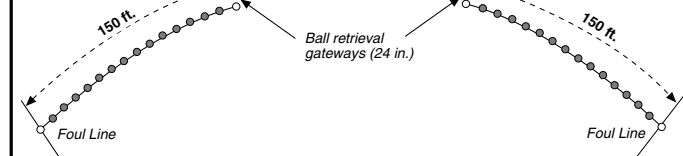

To calculate Fencing required; multiply Foul Line distance by 1.57.
Example: 180 ft. Foul Line x 1.57 = 282.6 ft.

Portable Fencing Installation Instructions

Courtesy of Markers, Inc.

33490 Pin Oak Parkway, Avon Lake, Ohio 44012

www.markersinc.com

The SmartPole™ Fence System

U.S. Patent #6,149,135

SmartStake™ Fence System

Complete Fence Kit Components

- 150 ft. Mesh Fencing Kits include:**
16 poles, each with 1 cap, 2 sleeves, (2 white reinforced end posts and 14 black posts)
150 ft. of Mesh Fencing
Rope & 50 Cable Ties
1 Pilot Hole Tool

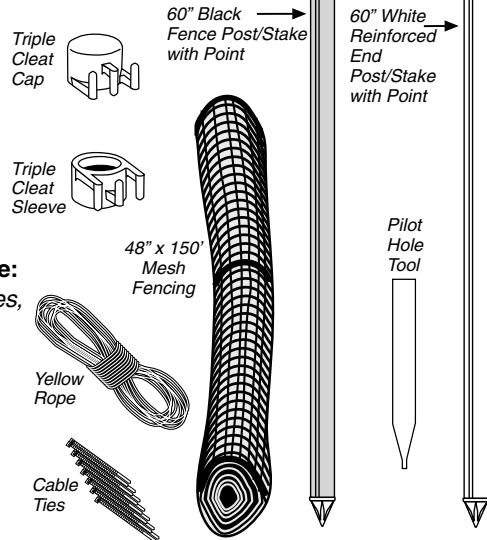

SmartPost™ Fence System

- Includes all items in our SmartStake System PLUS
16 Ground Sockets,
16 Plugs and
1 Socket Setter.

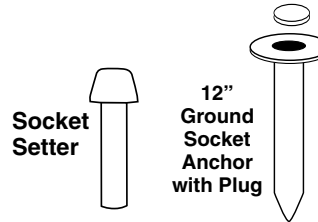

Fence Post Assembly and Installation

SmartStake™ Assembly

We suggest that gloves be worn when sliding Tri-Cleat™ sleeves in place along the shaft of the posts or stakes. There can be a lot of friction and heat in this assembly process.

Caps

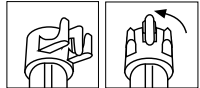

Place Cap on pole and twist sleeve 30° to left to create friction lock with pole ribbing.

Sleeves

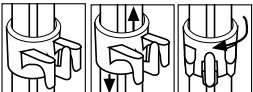

Hold Triple Cleat™ Sleeve on top of pole with center cleat to right of pole rib. Slide sleeve to desired height. Twist sleeve 30° to left to create friction lock with pole ribbing. To readjust location, twist sleeve to right, slide and twist left. Note: Sleeves should be installed with 2 points down as shown.

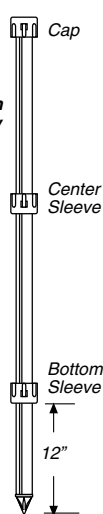

Installing SmartStakes

The SmartStake Kits are for Pound-in installations.

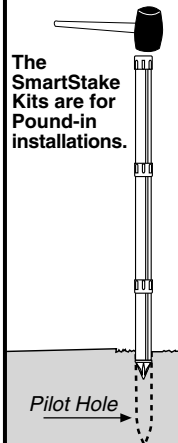

Creating Pilot Holes

Drive Installation Tool into ground with hammer or rubber mallet.

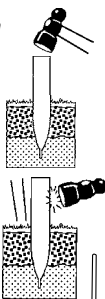

Gently tap Installation Tool from right to left to loosen & remove from ground.

Hint: For Faster Work, Drill Pilot Hole using our optional Auger - 1" dia. x 10" deep. Light pressure on Auger aids soil removal.

Installing SmartPosts with Ground Socket Anchors

To avoid socket damage, use the supplied Socket Setter and drive Ground Socket into the ground.

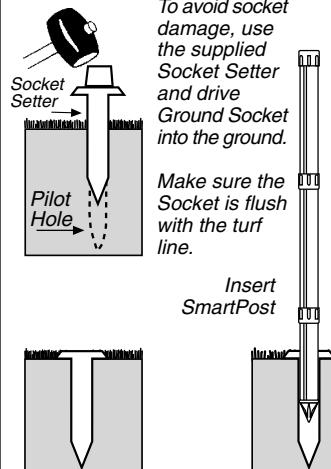

Make sure the Socket is flush with the turf line.

Insert SmartPost

“Value Added” Rope Support

We have included Rope and Cable Ties to add value and durability to your fence installation. The High-Visibility Yellow Rope, when installed at the top of the fence, provides added support and professional appearance to your field.

You can install the rope before or after you hang the fence, then install cable ties loosely when finished. Use 3 ties for every 10 ft. length between posts. Rope should slide freely through the black caps. Fencing material tends to sag after exposure to the elements. Simply untie, tighten and retie the rope to maintain a taut fence.

The “A” Knot for End Posts

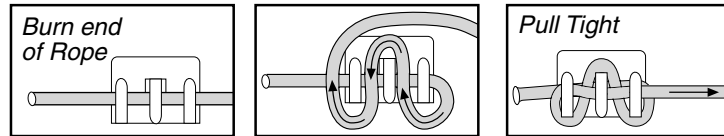

How to install:

Burn or melt the rope ends to prevent fraying.

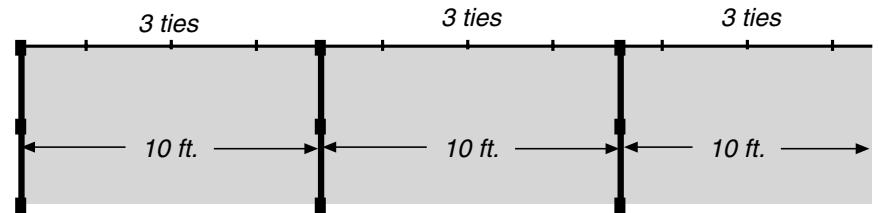
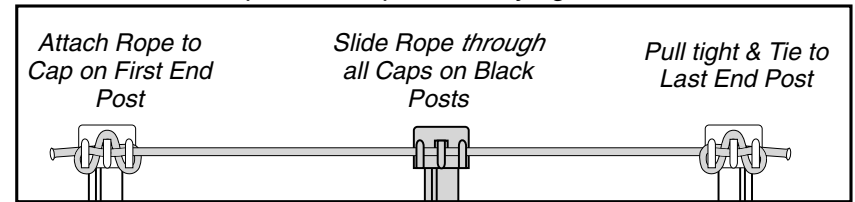

Our Fence Material

MESH STYLE FENCING

Our Mesh Fencing is designed with 3 Reinforced Bands - Top, Middle and Bottom - for added support at the point of anchoring. Attach Mesh Fencing material to cap - using Reinforced band at top of material. Then attach material to mid-point sleeve at Reinforced band, and finally to bottom sleeve. Reinforced Fence material may be pulled taut by moving sleeves up or down.

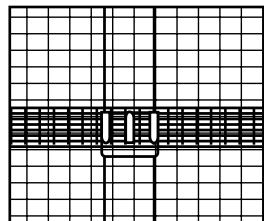
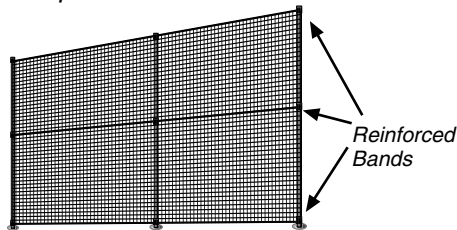

The Quick-Connect / Disconnect Fence Installation:

